









High Pressure Equipment

Reactor Selection Guide

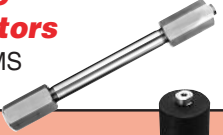
Reactor Design	Description	Standard Material	Maximum Temperature (degrees F)	Maximum Working Pressure (psi)	Standard Capacity
O-ring Seal Series OC 	Simple closure design allows for easy assembly/disassembly and reliable operation. Series OC are economical reactors ideal for low temperature gas or liquid service.	316SS	250	16,000	125 mL to 6,750 mL
Confined Gasket Closure Series GC 	Series GC is designed for studying high temperature and pressure reactions. The vessels utilize thrust bolts and a thrust ring to ensure positive seating of the gasket.	316SS	800	16,000	125 mL to 6,750 mL
Bolted Closure Series BC 	These versatile reactors are the standard of the industry for applications involving moderate pressure ranges. Standard O-rings may be used in place of the metal gasket for lower temperatures.	316SS	650	5,000	300 mL to 2 gal.
Clover Leaf Series CL 	Quick opening cover design needs only one-eighth of a turn rotation for sealing. Ideal for high pressure operations requiring repetitive opening/closing.	4340 alloy steel	250	30,000	1,000 mL to 3,700 mL
O-ring Closure Series R 	Designed for extremely high pressure/low temperature operation, series R reactors feature a threaded closure for easy assembly and disassembly.	4340 alloy steel	250	150,000	77 mL to 30 liters
Micro Reactors Series MS 	Series MS are fixed bed tubular reactors designed for a variety of applications such as small volume testing of components and miniature scale reaction tests.	316SS	800	30,000	2 mL to 64 mL
Tubular Reactors Series TOC 	This line of economical and versatile reactors satisfy many moderate pressure applications. Accumulators can be customized through a variety of options including piston separators.	304SS	O-ring 250 confined gasket 800	10,000	50 mL to 15 liters
Custom Reactors	HiP makes every reactor to order, allowing for economical and timely customizing. We offer a broad range of exotic metals, sizes and connections to meet virtually any requirement.	—	—	—	—

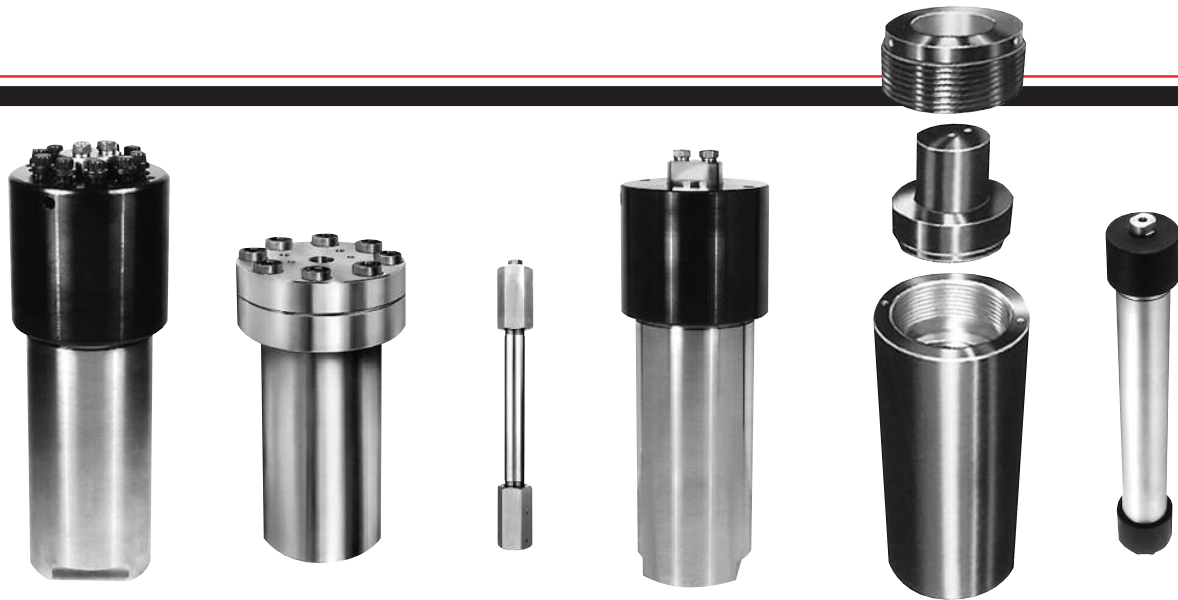

Pressure Vessel Volume Table (cubic inches)

Inside Depth (inches)	Inside Diameter (inches)												
	1/2"	1"	1 1/2"	2"	2 1/2"	3"	4"	5"	6"	7"	8"	9"	10"
4"	0.7856	3.142	7.068	12.57	19.63	28.27	50.26	78.54	113.1	153.9	201.1	254.5	314.2
6"	1.178	4.712	10.60	18.85	29.45	42.41	75.40	117.8	169.6	230.9	301.6	381.7	471.2
8"	1.571	6.283	14.14	25.13	39.27	56.55	100.5	157.1	226.2	307.9	402.1	508.9	628.4
10"	1.964	7.854	17.67	31.42	49.09	70.69	125.7	196.3	282.7	384.8	502.6	636.2	785.2
12"	2.357	9.425	21.21	37.70	58.90	84.82	150.8	235.6	339.3	461.8	603.2	763.4	942.4
14"	2.749	11.00	24.74	43.98	68.72	98.96	175.9	274.9	395.8	538.8	703.7	890.6	1100
16"	3.142	12.57	28.27	50.27	78.54	113.1	201.1	314.2	452.4	615.8	804.2	1018	1257
18"	3.535	14.14	31.81	56.55	88.36	127.2	226.2	353.4	508.9	692.7	904.8	1145	1415
20"	3.928	15.71	35.34	62.83	98.17	141.4	251.3	392.7	565.5	769.7	1005	1272	1571
22"	4.231	17.28	38.88	69.12	108.0	155.5	276.5	432.0	622.0	846.7	1106	1400	1728
24"	4.714	18.85	42.41	75.40	117.8	169.6	301.6	471.2	678.6	923.6	1206	1527	1885
26"	5.106	20.42	45.94	81.68	127.6	183.8	326.7	510.5	735.1	1001	1307	1654	2042
28"	5.499	21.99	49.48	87.96	137.4	197.9	351.8	549.8	791.7	1078	1407	1781	2199

Volume Equivalents

1 in³ = 16.39 mL
 1 mL = 0.061 in³
 1 gal = 231 in³ = 0.134 ft³
 1 ft³ = 1728 in³ = 7.481 gal
 1 L = 61.02 in³ = 0.264 gal

Pressure Conversions

	psi	atm	kg/cm ²
psi	1	0.068	0.070
atm	14.696	1	1.033
kg/cm ²	14.224	0.968	1